

*DynaScan*

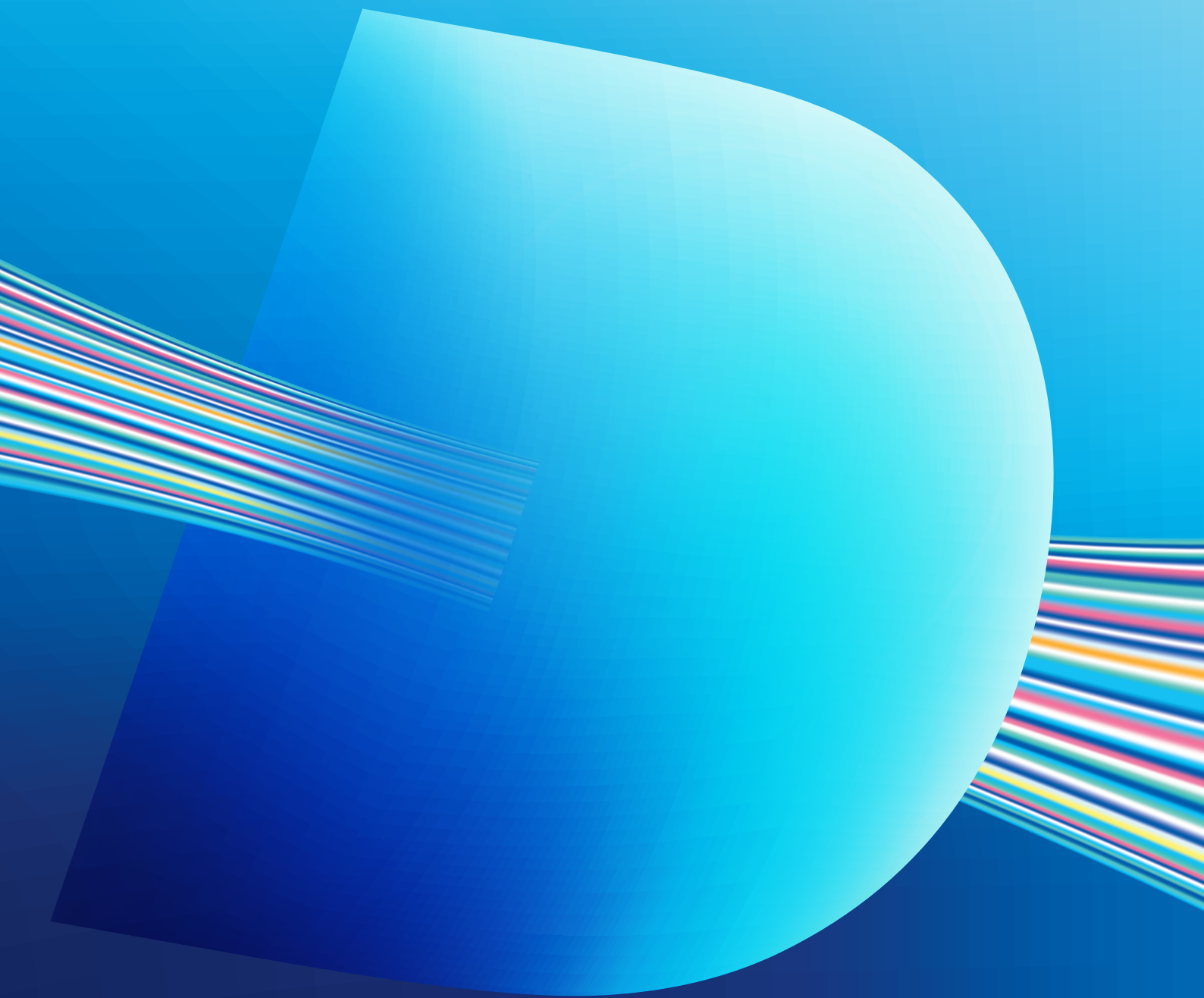

**PREMIUM  
VISUAL  
SOLUTIONS**

PRODUCT CATALOG





***DynaScan***

# Unifying Visions

At DynaScan, our goal has always been to create visual solutions that capture the viewer's attention and provide engagement. This year, we are taking that philosophy further by introducing a range of new display technologies to give our customers a diverse selection of display options to choose from.

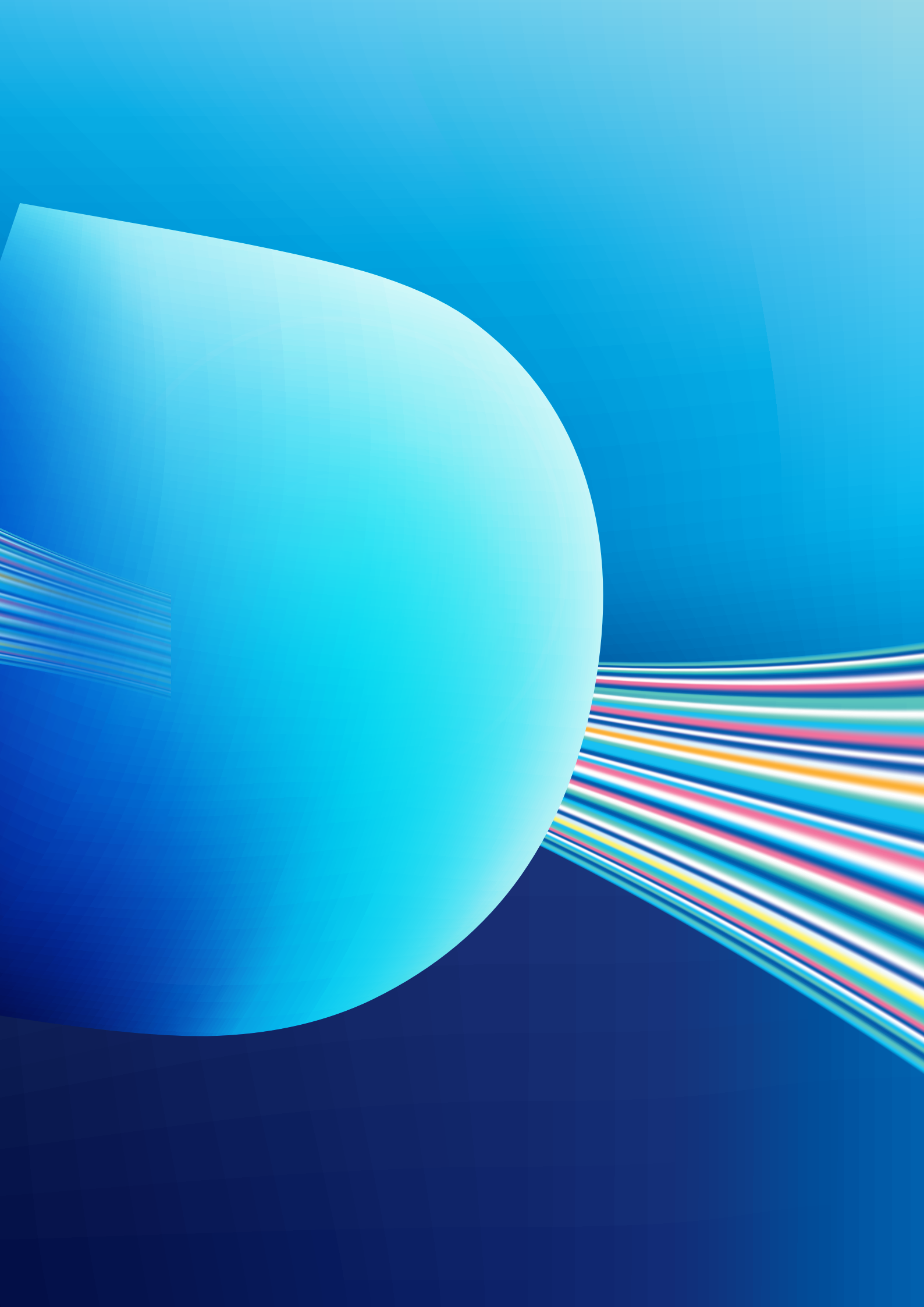



# BRIGHTER BY DESIGN

## ABOUT DYNASCAN

**MANUFACTURING SUPERIOR  
PROFESSIONAL DISPLAYS SINCE 1998**

DynaScan is a leading brand of professional LCD and LED displays. World-renowned for our high brightness displays, we continuously expand our portfolio with new products, solutions, and features. With offices in Asia, Europe and North America, we are uniquely equipped for international rollouts and client support.





Chroma



## PRODUCT CATEGORY

# INDOOR

With installations around the world, DynaScan displays are a proven solution for high ambient light applications. With brightness ratings as high as 6000 nits, DynaScan ultra-high brightness LCDs shine bright in direct sunlight—making them an ideal solution for window-facing applications, semi-outdoor, and brightly lit indoor environments.



## HIGH BRIGHTNESS LCD SOLUTION

As the first to produce a professional LCD specifically designed for use in direct sunlight, DynaScan continues to be the proven solution for high ambient light environments.

With brightness ratings as high as 6000 nits, DynaScan ultra-high brightness LCDs are among the brightest in the world, allowing them to shine bright in direct sunlight and are ideal for enclosures, kiosks, and window-facing applications.

Brightness doesn't come at a sacrifice of color quality. Every screen is TrueColor™ calibrated to ensure superb color quality and uniformity.

Not only are DynaScan UHB displays the brightest in the world, but with the lowest watt per nit ratings in the industry, they are also among the most power-efficient. DynaScan offers the widest variety of sizes models ranging from 32" to 86", and in brightness levels ranging from 2500 to 6000 nits.



**DynaScan**



## INDUSTRY TREND

Retailers are fighting to stand out from other stores with rapidly adapting and engaging messages that can only be accomplished in a digital medium. Within the time it takes to design, print, ship, and install a printed poster, the messaging needs could have easily changed.

High brightness displays are a necessity for window-facing digital signage; displays are competing against the reflection on the glass and the brightness of direct sunlight. Not only does DynaScan manufacture displays to overcome these challenges, but we've also designed them to accurately reproduce brand colors, skin tones, and colorways.

KEY FEATURE

# A WIDE VARIETY OF SIZES AND STYLES

One size does not fit all applications. DynaScan is the only manufacturer in the industry to offer a full range of high brightness LCDs ranging from 32" to 86" in standard and narrow bezel styles.



KEY FEATURE

# THE BRIGHTEST IN THE WORLD

DynaScan ultra-high brightness LCDs with maximum brightness ratings up to 6000 nits, which can easily be viewed in direct sunlight, such as storefront windows or outdoor enclosures without interference of glare from surrounding glass and reflections.



### TRUECOLOR™ CALIBRATED

Every screen is factory calibrated to D65 (6500K) CIE color standard. This color setting produces a natural looking image which has a correlated color temperature to that of daylight.



### BRIGHTNESS & COLOR GUARANTEED

All DynaScan high brightness LCDs are guaranteed to produce a bright, vivid image with a brightness and color degradation of no more than 9% over 5 year of continuous use.



### INTELLIGENT THERMAL MANAGEMENT

Heat generated by the display is radiated away from high temperature areas while a sensor continuously monitors the internal temperature to protect the system from overheating.





KEY FEATURE

# STOREFRONT WINDOW DISPLAYS

Digital media is only effective if viewers are able to see it. DynaScan high brightness professional LCDs are a perfect solution for indoor environments that receive a high amount of ambient light such as storefront windows.



## LOCAL DIMMING BACKLIGHT

The display features a proprietary local dimming LED back light technique for a remarkably high contrast picture. With direct local dimming, darker areas of an image receive less backlighting than lighter areas.



## LOW POWER CONSUMPTION

With low watts/nits ratings, DynaScan offers some of the most power-efficient, lowest power-consuming professional LCDs in the industry.

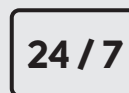

## PROFESSIONAL USE

Designed for worry-free 24/7 operation in both portrait and landscape orientations.

# SMALL

## 32" HIGH BRIGHTNESS DISPLAY

MODEL  
DS323LT4

SIZE  
32"

BRIGHTNESS  
2500 nits

RESOLUTION  
1920 x 1080



The DS323LT4 is a 32-inch professional high brightness LCD. With a brightness rating of 2500 nits, this display features an LED back light for high contrast picture quality and low power consumption.

## 37" BAR-TYPE HIGH BRIGHTNESS DISPLAY

MODEL  
DS371BT4

SIZE  
37"

BRIGHTNESS  
3000 nits

RESOLUTION  
1920 x 540

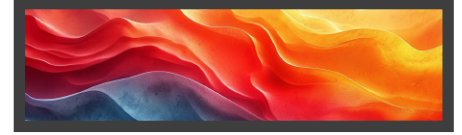

The DS371BT4 is a 37.5-inch high brightness stretched professional LCD. With a stretched 32:9 aspect ratio, the DS371BT4 is designed for special applications where height is limited.

## 43" HIGH BRIGHTNESS DISPLAY

MODEL  
DS431LT4

SIZE  
43"

BRIGHTNESS  
2500 nits

RESOLUTION  
1920 x 1080



The DS431LT4 is a 43-inch professional high brightness LCD with a 2500 nit brightness rating and 8.7 mm even bezel.

## MONITOR DIMENSION

### 32" HIGH BRIGHTNESS DISPLAY

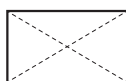

#### DS323LT4

719.6 x 415.7 x 76.6 mm  
28.33 x 16.37 x 3.02 inch

### 37" BAR-TYPE HIGH BRIGHTNESS DISPLAY

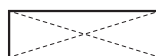

#### DS371BT4

914.9 x 280.8 x 51.5 mm  
36.02 x 11.05 x 2.03 inch

### 43" HIGH BRIGHTNESS DISPLAY

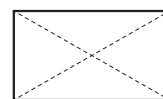

#### DS431LT4

962.1 x 552.0 x 77.4 mm  
37.88 x 21.73 x 3.05 inch



# MEDIUM

## 49" FANLESS HIGH BRIGHTNESS DISPLAY

MODEL  
DS49ILT5-1

SIZE  
49"

BRIGHTNESS  
4000 nits

RESOLUTION  
1920 x 1080



The DS49ILT5-1 is a full HD 49-inch high brightness LCD featuring fanless cooling technology. Integrated Android™ Media Player or optional Intel® SDM slot.

## 55" FANLESS HIGH BRIGHTNESS DISPLAY

MODEL  
DS552LT5-2

SIZE  
55"

BRIGHTNESS  
4000 nits

RESOLUTION  
1920 x 1080

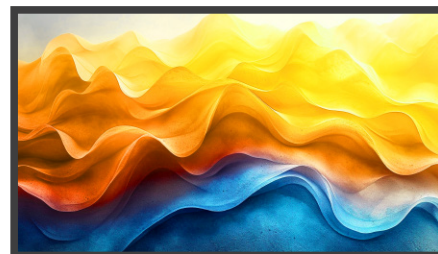

The DS552LT5-2 is a 55-inch high brightness professional LCD with fanless cooling. Integrated Android™ Media Player.

## MONITOR DIMENSION

### 49" FANLESS HIGH BRIGHTNESS DISPLAY

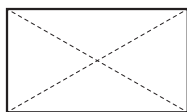

**DS49ILT5-1**  
1096.7 x 627.2 x 82.3 mm  
43.18 x 24.69 x 3.24 inch

### 55" FANLESS HIGH BRIGHTNESS DISPLAY

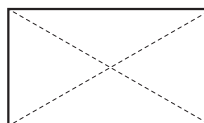

**DS552LT5-2**  
1239.4 x 710.0 x 87.7 mm  
48.80 x 27.95 x 3.45 inch



# LARGE

## 65" HIGH BRIGHTNESS DISPLAY

MODEL  
DS653LT5

SIZE  
65"

BRIGHTNESS  
4000 nits

RESOLUTION  
1920 x 1080



The DS653LT5 is a 65-inch professional ultra-high brightness (UHB) LCD with a maximum brightness rating of 4000 nits.

## 75" 4K UHD HIGH BRIGHTNESS DISPLAY

MODEL  
DS752LT5

SIZE  
75"

BRIGHTNESS  
4500 nits

RESOLUTION  
3840 x 2160



The DS752LT5 is an ultra HD 75-inch high brightness LCD featuring an LED backlight producing a 4500 nit sunlight viewable image.

## 86" 4K UHD HIGH BRIGHTNESS DISPLAY

MODEL  
DS861LR4

SIZE  
86"

BRIGHTNESS  
3500 nits

RESOLUTION  
3840 x 2160



The largest model in the DS series, measuring 86-inches diagonally, the display features a 4K UHD 86-inch LCD with a high brightness LED backlight producing a 3500 nit sunlight-viewable image.

## MONITOR DIMENSION



### 65" HIGH BRIGHTNESS DISPLAY

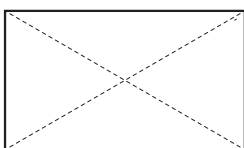

#### DS653LT5

1456.7 x 829.7 x 89.6 mm  
57.35 x 32.64 x 3.53 inch

### 75" 4K UHD HIGH BRIGHTNESS DISPLAY

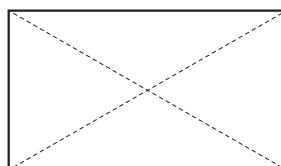

#### DS752LT5

1688 x 967.5 x 93.6 mm  
66.45 x 38.09 x 3.69 inch

### 86" 4K UHD HIGH BRIGHTNESS DISPLAY

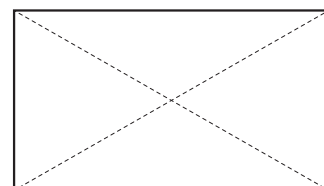

#### DS861LR4

1935.8 x 1106.8 x 79.0 mm  
76.21 x 43.57 x 3.11 inch



# SPECIFICATIONS

All specifications subject to change without notice.

## SMALL

	32" HIGH BRIGHTNESS DISPLAY	37" BAR-TYPE HIGH BRIGHTNESS DISPLAY	43" HIGH BRIGHTNESS DISPLAY	
	DS323LT4	DS371BT4	DS431LT4	
<b>PANEL</b>	Model	DS323LT4	DS371BT4	DS431LT4
	LCD Panel Size	31.55"	37"	42.5"
	Native Resolution	1920 x 1080	1920 x 540	1920 x 1080
	Brightness	2500 nits	3000 nits	2500 nits
	Color Depth	10 bits	8 bits	8 bits
	Contrast Ratio	1300:1	4000:1	4000:1
	Response Time (Typ.)	9 ms	16 ms	8 ms
	Viewing Angle	178° / 178°	178° / 178°	178° / 178°
	Light Lifetime (Typ.)	100,000 hrs	50000 hrs	100,000 hrs
Polarized Sunglasses Support	-	-	-	
<b>POWER</b>	Power Supply	Internal	Internal	Internal
	Rated Voltage	100-240V ~ 50/60Hz	100-240V ~ 50/60Hz	100-240V ~ 50/60Hz
	Power Consumption (Typ./ Max.)	145 W	95 W / 145 W	220 W
<b>MECHANICAL</b>	Bezel Width (T/B/L/R)	8.7 / 8.7 / 8.7 / 8.7 mm	11.7 / 11.7 / 5.6 / 5.6 mm	8.7 / 8.7 / 8.7 / 8.7 mm
	Monitor Dimension (LxHxD)	719.6 x 415.7 x 76.6 mm	914.9 x 280.8 x 51.5 mm	962.1 x 552.0 x 77.4 mm
	Monitor Weight	9.8 kg	9 kg	18.1 kg
	VESA Mounting (LxH)	200 x 200 mm	200 x 100 mm	400 x 200 mm
<b>FEATURE</b>	Language	English	English	English
	Built-in Video Wall Support	-	Up to 15x15	-
	Support SNMP (Up to V3.0)	Yes	Yes	Yes
	Image Retention Protection	Yes	Yes	Yes
	Auto Orientation Sensor	Yes	Yes	Yes
	Ambient Light Sensor	Yes	Yes	Yes
	Power On/Off Scheduling	Yes	Yes	Yes
OSD Menu Rotation	Yes	Yes	Yes	
<b>INPUT</b>	HDMI 1.4b (HDCP 1.4)	-	x1 (1080p)	-
	HDMI 2.1 (HDCP 2.3)	x2 (1080p recommended)	-	x2 (1080p recommended)
	DVI-D	-	x1	-
	DisplayPort	-	x1	-
	USB 2.0	x2	x1 (For Internal Player)	x2
	USB 3.0	-	-	-
	SD Slot	-	x1 (For Internal Player)	-
	Micro SD Slot	-	-	-
	VGA	-	-	-
Audio	-	-	-	
<b>OUTPUT</b>	DVI-D	-	x1	-
	Audio	x1	x1	x1
<b>EXTERNAL CONTROL</b>	RS-232	In x1	In x1, Out x1	In x1
	RJ-45	x1 (LAN)	x1 (LAN)	x1 (LAN)
<b>INTERNAL PLAYER</b>	Operating System	Android 11.0	Android 4.4.2	Android 11.0
	Processor	Quad-core A53	ARM Quad-Core Cortex-A9	Quad-core A53
	Clock Speed	1.5GHz	1.6 GHz	1.5GHz
	Main Memory Interface	DDR4, 2GB	DDR3L-1066, 1GB	DDR4, 2GB
	Graphics	Mali G52	Mali400MP4 support OpenGL ES1.1/2.0, Open VGL1	Mali G52
Wi-Fi Specification	802.11a/b/g/n/ac (2T2R)   2.4GHz/5GHz	802.11 b/g/n   2412.0MHz - 2462.0MHz	802.11a/b/g/n/ac (2T2R)   2.4GHz/5GHz	
<b>ENVIRONMENT</b>	Operating Temperature	0°~ 45° C	0°~ 40° C	0°~ 45° C
	Storage Temperature	-20°~60° C	-20°~60° C	-20°~60° C
	Humidity	10% ~ 80% RH Non-condensing	10% ~ 80% RH Non-condensing	10% ~ 80% RH Non-condensing
<b>CERTIFICATION</b>	CE / FCC / RoHS	CE / FCC / RoHS	CE / FCC / RoHS	
<b>ACCESSORIES</b>	Quick Start Guide	Quick Start Guide	Quick Start Guide	
	Power Cord	Power Cable	Power Cord	
	Remote Control (2 Batteries included)	Remote Control (2 Batteries included)	Remote Control (2 Batteries included)	
	IR & Ambient Sensor	IR & Ambient Sensor	IR & Ambient Sensor	
Thermal Sensor Kit 302 (optional)	Thermal Sensor Kit 201 (optional)	Thermal Sensor Kit 302 (optional)		

# SPECIFICATIONS

All specifications subject to change without notice.

## MEDIUM

	49" FANLESS HIGH BRIGHTNESS DISPLAY	55" FANLESS HIGH BRIGHTNESS DISPLAY	
	DS49ILT5-1	DS55ILT5-2	
Model			
<b>PANEL</b>	LCD Panel Size	48.5"	54.64"
	Native Resolution	1920 x 1080	1920 x 1080
	Brightness	4000 nits	4000 nits
	Color Depth	10 bits	8 bits
	Contrast Ratio	3000 : 1	3000 : 1
	Response Time (Typ.)	8 ms (Typ.)	9 ms
	Viewing Angle	178° / 178°	178° / 178°
	Light Lifetime (Typ.)	100,000 hrs	100,000 hrs
Polarized Sunglasses Support	Yes	Yes	
<b>POWER</b>	Power Supply	Internal	Internal
	Rated Voltage	100-240V ~ 50/60Hz	100-240V ~ 50/60Hz
	Power Consumption (Typ./ Max.)	110 W / 240 W	115 W / 260 W
<b>MECHANICAL</b>	Bezel Width (T/B/L/R)	8.7 / 8.7 / 8.5 / 8.5 mm	10.9 / 10.9 / 10.9 / 10.9 mm
	Monitor Dimension (LxHxD)	1096.7 x 627.2 x 82.3 mm	1239.4 x 710.0 x 87.7 mm
	Monitor Weight	20 kg	27.5 kg
	VESA Mounting (LxH)	400 x 400 mm	400 x 400 mm
<b>FEATURE</b>	Language	English	English
	Built-in Video Wall Support	-	-
	Support SNMP (Up to V3.0)	Yes	Yes
	Image Retention Protection	Yes	Yes
	Auto Orientation Sensor	Yes	Yes
	Ambient Light Sensor	Yes	Yes
	Power On/Off Scheduling	Yes	Yes
OSD Menu Rotation	Yes	Yes	
<b>INPUT</b>	HDMI 1.4b (HDCP 1.4)	-	-
	HDMI 2.1 (HDCP 2.3)	x2 (1080p recommended)	x2 (1080p recommended)
	DVI-D	-	-
	DisplayPort	-	-
	USB 2.0	x2	x2
	USB 3.0	-	-
	SD Slot	-	-
	Micro SD Slot	-	-
	VGA	-	-
Audio	-	-	
<b>OUTPUT</b>	DVI-D	-	-
	Audio	x1	x1
<b>EXTERNAL CONTROL</b>	RS-232	In x1	In x1
	RJ-45	x1 (LAN)	x1 (LAN)
<b>INTERNAL PLAYER</b>	Operating System	Android 11.0	Android 11.0
	Processor	Quad-core A53	Quad-core A53
	Clock Speed	1.5GHz	1.5GHz
	Main Memory Interface	DDR4, 2GB	DDR4, 2GB
	Graphics	Mali G52	Mali G52
Wi-Fi Specification	802.11a/b/g/n/ac (2T2R)   2.4GHz/5GHz	802.11a/b/g/n/ac (2T2R)   2.4GHz/5GHz	
<b>ENVIRONMENT</b>	Operating Temperature	0°~ 45° C	0°~ 45° C
	Storage Temperature	-20°~60° C	-20°~60° C
	Humidity	10% ~ 80% RH Non-condensing	10% ~ 80% RH Non-condensing
<b>CERTIFICATION</b>	CE / FCC / RoHS	CE / FCC / RoHS	
<b>ACCESSORIES</b>	Quick Start Guide	Quick Start Guide	Quick Start Guide
	Power Cord	Power Cord	Power Cord
	Remote Control (2 Batteries included)	Remote Control (2 Batteries included)	Remote Control (2 Batteries included)
	IR & Ambient Sensor	IR & Ambient Sensor	IR & Ambient Sensor
	Thermal Sensor Kit 302 (optional)	Thermal Sensor Kit 302 (optional)	Thermal Sensor Kit 302 (optional)

# SPECIFICATIONS

All specifications subject to change without notice.

## LARGE

	65" HIGH BRIGHTNESS DISPLAY	75" 4K UHD HIGH BRIGHTNESS DISPLAY	86" 4K UHD HIGH BRIGHTNESS DISPLAY	
	DS653LT5	DS752LT5	DS861LR4	
<b>PANEL</b>	Model	DS653LT5	DS752LT5	DS861LR4
	LCD Panel Size	65"	74.52"	85.6"
	Native Resolution	1920 x 1080	3840 x 2160	3840 x 2160
	Brightness	4,000 nits	4,500 nits	3,500 nits
	Color Depth	10 bits	10 bits	10 bits
	Contrast Ratio	4000 : 1	3000 : 1	3000 : 1
	Response Time (Typ.)	8 ms	8 ms	8 ms
	Viewing Angle	178° / 178°	178° / 178°	178° / 178°
	Light Lifetime (Typ.)	100,000 hrs	100,000 hrs	100,000 hrs
Polarized Sunglasses Support	Yes	Yes	Yes	
<b>POWER</b>	Power Supply	Internal	Internal	Internal
	Rated Voltage	100-240V ~ 50/60Hz	100-240V ~ 50/60Hz	100-240V ~ 50/60Hz
	Power Consumption (Typ./ Max.)	255 W / 550 W	420 W / 800 W	750 W / 1300 W
<b>MECHANICAL</b>	Bezel Width (T/B/L/R)	11.8 / 11.8 / 11.8 / 11.8 mm	17.0 / 17.0 / 16.5 / 16.5 mm	17.8 / 17.8 / 17.8 / 17.8 mm
	Monitor Dimension (LxHxD)	1456.7 x 829.7 x 89.6 mm	1688 x 967.5 x 93.6 mm	1935.8 x 1106.8 x 79.0 mm
	Monitor Weight	39.1 kg	58 kg	77 kg
	VESA Mounting (LxH)	400 x 400 mm, 600 x 400 mm	800 x 400 mm	600 x 400 mm
<b>FEATURE</b>	Language	English	English	English
	Built-in Video Wall Support	-	-	-
	Support SNMP (Up to V3.0)	Yes	Yes	Yes
	Image Retention Protection	Yes	Yes	Yes
	Auto Orientation Sensor	Yes	Yes	Yes
	Ambient Light Sensor	Yes	Yes	Yes
	Power On/Off Scheduling	Yes	Yes	Yes
OSD Menu Rotation	Yes	Yes	Yes	
<b>INPUT</b>	HDMI 1.4b (HDCP 1.4)	-	-	-
	HDMI 2.1 (HDCP 2.3)	x2 (1080p recommended)	x2 (2160P)	x2 (2160P)
	DVI-D	-	-	-
	DisplayPort	x1	x1	x1
	USB 2.0	-	-	-
	USB 3.0	x1	x1	x1
	SD Slot	-	-	-
	Micro SD Slot	x1	x1	x1
	VGA	-	-	-
Audio	-	-	-	
<b>OUTPUT</b>	DVI-D	-	-	-
	Audio	x1	x1	x1
<b>EXTERNAL CONTROL</b>	RS-232	In x1	In x1	In x1
	RJ-45	x2 (LAN)	x2 (LAN)	x2 (LAN)
<b>INTERNAL PLAYER</b>	Operating System	Android 8.0.0	Android 8.0.0	Android 8.0.0
	Processor	Dual-core A73 and dual-core A53	Dual-core A73 and dual-core A53	Dual-core A73 and dual-core A53
	Clock Speed	1.5GHz	1.5GHz	1.5GHz
	Main Memory Interface	DDR4, 2G	DDR4, 2G	DDR4, 2G
	Graphics	Quad-core MaliG51	Quad-core MaliG51	Quad-core MaliG51
Wi-Fi Specification	802.11 b/g/n   2412.0MHz - 2462.0MHz	802.11 b/g/n   2412.0MHz - 2462.0MHz	802.11 b/g/n   2412.0MHz - 2462.0MHz	
<b>ENVIRONMENT</b>	Operating Temperature	0°~ 45° C	0°~ 45° C	0°~ 45° C
	Storage Temperature	-20°~60° C	-20°~60° C	-20°~60° C
	Humidity	10% ~ 80% RH Non-condensing	10% ~ 80% RH Non-condensing	10% ~ 80% RH Non-condensing
<b>CERTIFICATION</b>	CE / FCC / RoHS	CE / FCC / RoHS	CE / FCC / RoHS	
<b>ACCESSORIES</b>	Quick Start Guide	Quick Start Guide	Quick Start Guide	
	Power Cord	Power Cord	Power Cord	
	Remote Control (2 Batteries included)	Remote Control (2 Batteries included)	Remote Control (2 Batteries included)	
	IR & Ambient Sensor Thermal Sensor Kit 202 (optional)	IR & Ambient Sensor Thermal Sensor Kit 302 (optional)	IR & Ambient Sensor Thermal Sensor Kit 302 (optional)	



## PRODUCT CATEGORY

# INDOOR

With installations around the world, DynaScan displays are a proven solution for high ambient light applications. With brightness ratings as high as 6000 nits, DynaScan ultra-high brightness LCDs shine bright in direct sunlight—making them an ideal solution for window-facing applications, semi-outdoor, and brightly lit indoor environments.



## ALL-IN-ONE WINDOW SOLUTION

Building on the success of the DS Series, the DynaScan DW Series offers an all-in-one solution specifically designed for window-facing display applications.

The DW Series offers users a complete display solution with high-end design features such as hidden cable management, portrait and landscape orientations, and versatile mounting options such as ceiling mount and floor stand compatibility.

Features, such as dual-sided display technology, allow store owners to reach customers outside their location with an ultra-bright sunlight-readable image while offering indoor brightness on the reverse for in-store communication.

Every screen is TrueColor™ calibrated to ensure superb color quality and uniformity and features auto-brightness control sensors to automatically dim the display as lighting conditions change.



**DynaScan**





## INDUSTRY TREND

Window-facing digital signage is one of the key areas of real estate for store owners, restaurants, and service retailers to communicate with potential customers. Signage has the power to bring customers inside a store, educate customers of current promotions, and in turn increase revenue.

This is exceptionally helpful in industries such as fast fashion—in which styles are changing on a continuous basis—and restaurants, where daily specials and new menu additions can be visually displayed.

## KEY FEATURE

# DUAL-SIDED DESIGN

A double-sided display offers the flexibility to present different messaging points to customers inside as well as potential customers outside. A sunlight-viewable side shines bright in the window to allow visibility outdoors, while the reverse side offers reduced brightness for the indoor environment.

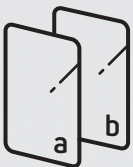
**DUAL-SIDED DESIGN**

A double-sided display offers the flexibility to present different messaging points to viewers on either side.

**CLEAN BACK DESIGN**

The product features a clean and sleek design, an attractive back panel, lightweight construction, and a narrow bezel design, enhancing its overall elegance for display purposes.

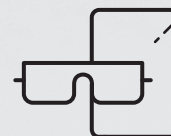
**VIEWABLE WITH POLARIZED LENSES**

To ensure the image can be clearly seen throughout the day, the display utilizes quarter-wave plate technology to prevent dark images when viewing with polarized sunglasses.



DynaScan DW Series  
The winner of  
iF Design Award 2024



#### KEY FEATURE

## VERSATILE CONFIGURATION

The DW Series is designed to be as versatile as possible—offering a variety of installation configurations in either portrait or landscape orientation. Whether hanging the display from the ceiling or positioning the display on the floor, optional mounting kits offer simple and versatile installation options.



#### TRUECOLOR™ CALIBRATED

Every screen is factory calibrated to the D65 (6500K) CIE color standard, producing a natural-looking image which has a correlated color temperature to that of daylight.



#### AUTO BRIGHTNESS CONTROL

Different external lighting conditions require different brightness levels. An onboard light sensor measures the ambient light in the area and automatically adjusts the image accordingly.

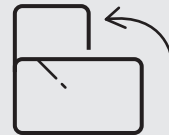

#### PORTRAIT & LANDSCAPE

The DW Series can be installed in both a landscape or portrait orientation to suit the needs of the application.

## 55" DUAL-SIDED HIGH BRIGHTNESS DISPLAY

MODEL  
DW551DR4-1

SIZE  
55" x 2

BRIGHTNESS  
1000 / 3000 nits

RESOLUTION  
1920 x 1080



Dual-sided design, brightness: 3,000 nit front & 1,000 nit rear, blackening defect-free in direct sunlight, two Integrated Android™ media player or optional Intel® SDM slot, 1920x1080 full HD native resolution, all-metal construction.

## 55" CLEAN BACK HIGH BRIGHTNESS DISPLAY

MODEL  
DW551LR5

SIZE  
55"

BRIGHTNESS  
4000 nits

RESOLUTION  
1920 x 1080

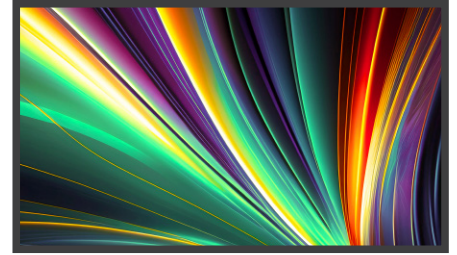

Single-sided design, brightness: 4,000 nit front & clean-back rear, blackening defect-free in direct sunlight, Integrated Android™ media player or optional Intel® SDM slot, 1920x1080 full HD native resolution, all-metal construction.

## 65" 4K UHD CLEAN BACK HIGH BRIGHTNESS DISPLAY

MODEL  
DW652LR5

SIZE  
65"

BRIGHTNESS  
4000 nits

RESOLUTION  
3840 x 2160

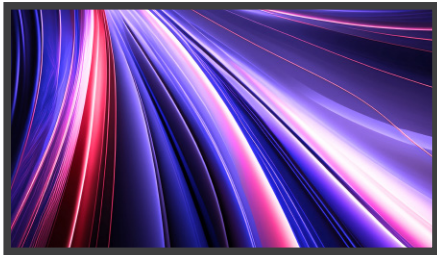

Single-sided design, brightness: 4,000 nit front & clean-back rear, blackening defect-free in direct sunlight, Integrated Android™ media player or optional Intel® SDM slot, 3840x2160 4K UHD native resolution, all-metal construction.

## MONITOR DIMENSION



**OPTIONAL KIT | STAND KIT**

MODEL  
ISK551DR-P1050

APPLICABLE MODELS  
DW551DR4-1

DIMENSION (W x H x D)  
744.7 x 1050 x 175 mm

LOAD CAPACITY  
200 kg

Slim & Sleek Design  
Screwless Appearance  
Quick Assembly  
Concealed Cable Management

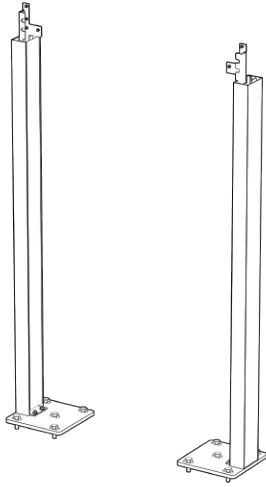

**OPTIONAL KIT | HANGING KIT**

MODEL  
IHK551DR-3000

APPLICABLE MODELS  
DW551DR4-1

LENGTH OF WIRE  
3000 mm (adjustable)

LOAD CAPACITY  
200 kg

Zero Footprint  
Adjustable Length  
Portrait & Landscape  
Compatible Total 200 kg Capacity  
Quick Height Adjustment

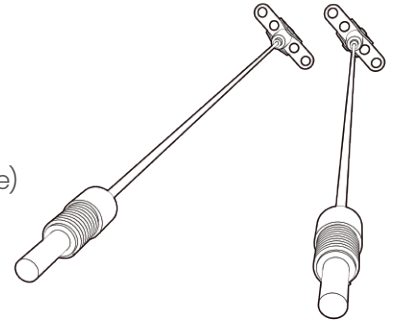

**MONITOR DIMENSION**

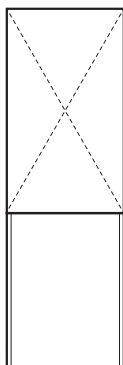

**STAND KIT  
ISK551DR-P1050**  
744.7 x 1050.0 x 175.0 mm  
29.3 x 41.3 x 6.9 inch

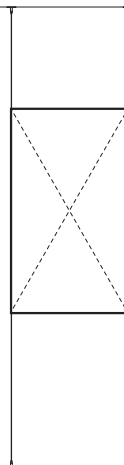

**HANGING KIT  
IHK551DR-3000**  
Length 3000 mm (adjustable)  
Length 118 inch (adjustable)



**OPTIONAL KIT | STAND KIT**

MODEL  
ISKLR-1050

APPLICABLE MODELS  
DW551LR5 / DW652LR5

DIMENSION (W x H x D)  
847.4 x 1050 x 175 mm

LOAD CAPACITY  
200 kg

- Slim & Sleek Design
- Screwless Appearance
- Quick Assembly
- Concealed Cable Management

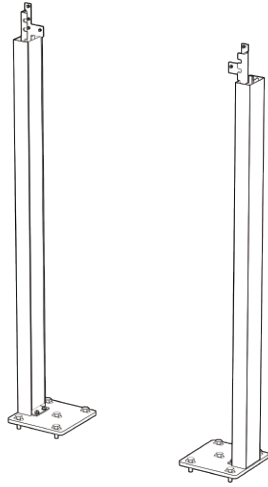

**OPTIONAL KIT | HANGING KIT**

MODEL  
IHKLR-3000

APPLICABLE MODELS  
DW551LR5 / DW652LR5

LENGTH OF WIRE  
3000 mm (adjustable)

LOAD CAPACITY  
200 kg

- Zero Footprint
- Adjustable Length
- Portrait & Landscape
- Compatible Total 200 kg Capacity
- Quick Height Adjustment

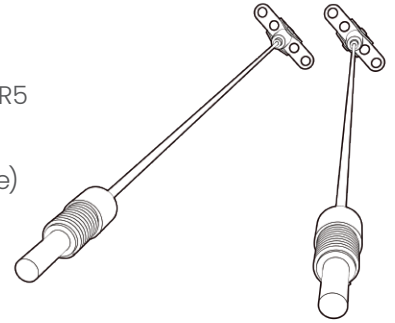

**MONITOR DIMENSION**

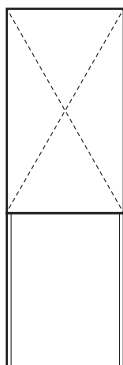

**STAND KIT  
ISKLR-1050**  
847.4 x 1050 x 175 mm  
33.4 x 41.3 x 6.9 inch

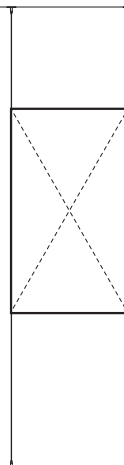

**HANGING KIT  
IHKLR-3000**  
Length 3000 mm (adjustable)  
Length 118 inch (adjustable)



# SPECIFICATIONS

All specifications subject to change without notice.

	55" DUAL-SIDED HIGH BRIGHTNESS DISPLAY	55" CLEAN BACK HIGH BRIGHTNESS DISPLAY	65" 4K UHD CLEAN BACK HIGH BRIGHTNESS DISPLAY	
	DW551DR4-1	DW551LR5	DW652LR5	
<b>PANEL</b>	Model	DW551DR4-1	DW551LR5	DW652LR5
	LCD Panel Size	54.64" x2	54.64"	64.53"
	Native Resolution	1920 x 1080	1920 x 1080	3840 x 2160
	Brightness	1000 nits / 3000 nits	4000 nits	4000 nits
	Color Depth	8 bits	8 bits	10 bits
	Contrast Ratio	3000 : 1	3000 : 1	1200 : 1
	Response Time (Typ.)	9 ms (Typ.)	9 ms (Typ.)	9 ms (Typ.)
	Viewing Angle	178° / 178°	178° / 178°	178° / 178°
Light Lifetime (Typ.)	100,000 hrs	100,000 hrs	100,000 hrs	
Polarized Sunglasses Support	Yes	Yes	Yes	
<b>POWER</b>	Power Supply	Internal	Internal	Internal
	Rated Voltage	100-240V ~ 50/60Hz	100-240V ~ 50/60Hz	100-240V ~ 50/60Hz
	Power Consumption (Typ./ Max.)	380 W	130 W / 260 W	240 W / 490 W
<b>MECHANICAL</b>	Bezel Width (T/B/L/R)	29.5 / 29.5 / 29.5 / 29.5 mm	11 / 11 / 11 / 11 mm	19 / 19 / 19 / 19 mm
	Monitor Dimension (LxHxD)	1272.8 x 743.3 x 62.7 mm	1240.4 x 710.7 x 74.3 mm	1472.2 x 847.4 x 74.3 mm
	Monitor Weight	40 kg	27 kg	39 kg
	VESA Mounting (LxH)	Portrait / Landscape / Portrait Flip	Portrait / Landscape / Portrait Flip	Portrait / Landscape / Portrait Flip
<b>FEATURE</b>	Language	English	English	English
	Built-in Video Wall Support	-	-	-
	Support SNMP (Up to V3.0)	Yes	Yes	Yes
	Image Retention Protection	Yes	Yes	Yes
	Auto Orientation Sensor	Yes	Yes	Yes
	Ambient Light Sensor	Yes	Yes	Yes
	Power On/Off Scheduling	Yes	Yes	Yes
OSD Menu Rotation	Yes	Yes	Yes	
<b>INPUT</b>	HDMI 1.4b (HDCP 1.4)	-	-	-
	HDMI 2.1 (HDCP 2.3)	x2 (1080p recommended)	x2 (1080p recommended)	x2 (2160p)
	DVI-D	-	-	-
	DisplayPort	-	-	-
	USB 2.0	x2	x2	-
	USB 3.0	-	-	x1
	SD Slot	-	-	-
	Micro SD Slot	-	-	x1
	VGA	-	-	-
Audio	-	-	-	
<b>OUTPUT</b>	DVI-D	-	-	-
	Audio	x2	x1	x1
<b>EXTERNAL CONTROL</b>	RS-232	In x1	In x1	In x1
	RJ-45	x2 (LAN)	x1 (LAN)	x2 (LAN)
<b>INTERNAL PLAYER</b>	Operating System	Android 11.0	Android 11.0	Android 11.0
	Processor	Quad-core A53	Quad-core A53	Quad-core A73
	Clock Speed	1.5 GHz	1.5 GHz	1.8 GHz
	Main Memory Interface	DDR4, 2GB	DDR4, 2GB	DDR4, 4GB
	Graphics	Mali G52	Mali G52	Mali G52
	Wi-Fi Specification	802.11a/b/g/n/ac (2T2R)   2.4GHz / 5GHz	802.11a/b/g/n/ac (2T2R)   2.4GHz / 5GHz	802.11a/b/g/n/ac (2T2R)   2.4GHz / 5GHz
<b>ENVIRONMENT</b>	Operating Temperature	0°~ 45° C	0°~ 45° C	0°~ 45° C
	Storage Temperature	-20°~60° C	-20°~60° C	-20°~60° C
	Humidity	10% ~ 80% RH Non-condensing	10% ~ 80% RH Non-condensing	10% ~ 80% RH Non-condensing
<b>CERTIFICATION</b>	CE / FCC / RoHS	CE / FCC / RoHS	CE / FCC / RoHS	
<b>ACCESSORIES</b>	Quick Start Guide	Quick Start Guide	Quick Start Guide	
	Power Cord	Power Cord	Power Cord	
	Remote Control (2 Batteries included)	Remote Control (2 Batteries included)	Remote Control (2 Batteries included)	
	IR & Ambient Sensor	IR & Ambient Sensor	IR & Ambient Sensor	
	Thermal Sensor Kit 302 (optional)	Thermal Sensor Kit 302 (optional)	Thermal Sensor Kit 302 (optional)	



## PRODUCT CATEGORY

# OUTDOOR

DynaScan outdoor displays offer direct sunlight viewable images with year-round performance in inclement weather. DynaScan outdoor displays are IP-rated for protection from water and dust and feature IK10 vandal resistance for security and safety. The DO Series is designed as a ready-to-use solution for standalone applications while the DK Series offers a complete, robust all-in-one double-sided kiosk solution.

## OUTDOOR KIOSK SOLUTIONS

Building on our legacy as a pioneer of sunlight-viewable digital signage displays DynaScan introduces a new line of outdoor digital signage kiosks that have been designed, developed, and manufactured from the ground up for year-round performance in direct sunlight and inclement weather.

Featuring an eye-catching large-format double-sided design and an ultra-bright image as high as 4000 nits, the new DK Series gives advertisers, venue owners, and municipalities the performance to clearly communicate with their audiences.

DynaScan outdoor kiosks are designed with high-performance visibility, security, and versatility in mind. From stadiums to smart cities, DynaScan outdoor kiosks are ideal for a wide variety of applications.

Features like an ultra-high brightness image up to 4000 nits provide an easy-to-see image in direct sunlight, while optional network connectivity gives operators the power to monitor, control, and troubleshoot from virtually anywhere.



**DynaScan**





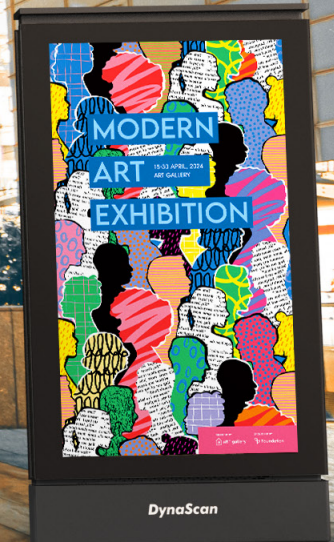

## INDUSTRY TREND

Outdoor digital signage kiosks offer advertisers opportunities that were simply not previously available with static posters. With the right approach, outdoor digital signage can be an excellent facilitator between the public and city services by providing timely communication about city services, educating communities about local events and news, as well as promoting local businesses.

Digital content can not only change throughout the day or week, but it can even be custom tailored for a variety of environmental factors such as a fast food restaurant promoting ice cream offerings when the temperature exceeds a certain threshold, or a clothing retailer can show the latest outerwear designs in cold weather. Additionally, digital displays can utilize real-time data to analyze campaign performance and help tailor future messaging.

OUTDOOR

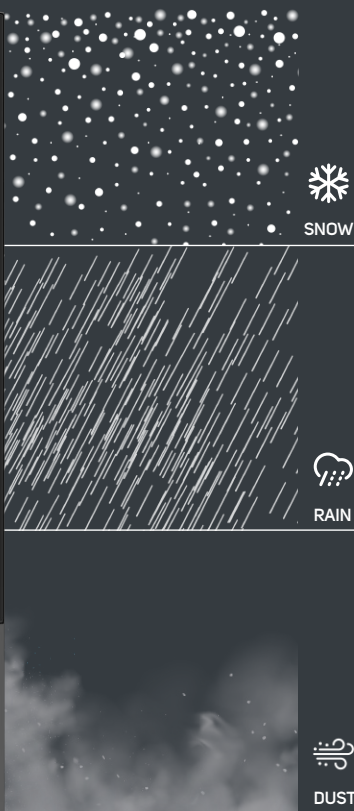

## IP-RATED WEATHER RESISTANT

Rain or shine, DynaScan outdoor displays can endure what mother nature has to offer. All-metal rustproof construction with IP56 weather protection resists water and dust from entering the display even in some of the harshest environments.

## FILTERLESS DESIGN

Filters not only reduce cooling efficiency by lowering air intake, but they can also cause a product failure if not properly maintained. DynaScan employs a proprietary thermal management system that doesn't require filters.



### DUAL-SIDED DESIGN

A double-sided display offers the flexibility to present different messaging points to viewers on either side.



### HIGH BRIGHTNESS SUNLIGHT VIEWABLE IMAGE

With sustained brightness of 4000 nits, DynaScan outdoor kiosks are easily viewed in direct sunlight.



### VIEWABLE WITH POLARIZED LENSES

To ensure the image can be clearly seen throughout the day, the display utilizes quarter-wave plate technology to prevent dark images when viewing with polarized sunglasses.

# VANDAL RESISTANT IK10 RATED

With a tough, steel frame and double laminated glass with IK10 protection, DynaScan outdoor displays are durable and secure.



## ROBUST, READY-TO-INSTALL OUTDOOR SOLUTION

With an all-in-one design and a variety of video input options, DynaScan outdoor kiosks offer a feature-packed display solution that is ready for rapid deployment.

# 100,000

### 100,000 HRS. BACKLIGHT LIFETIME

Designed for worry-free 24/7 operation in both portrait and landscape orientations for years to come.



### REMOTE OPERATION & CONTROL \*

Onboard sensors continuously monitor conditions such as internal temperature, brightness, and power status, providing network operators with vital information about the display's performance.

\*Available as an optional add-on



### INTELLIGENT THERMAL MANAGEMENT

A hybrid thermal management system of customized dual heat sinks provides constant passive cooling without any power usage at lower temperatures.

# DIMENSIONS

All specifications subject to change without notice.

## 65" DUAL-SIDED OUTDOOR KIOSK

Model DK651DR5

## 75" 4K UHD SINGLE-SIDED OUTDOOR KIOSK

Model DK751LN5

Model

Unit: mm [inch]

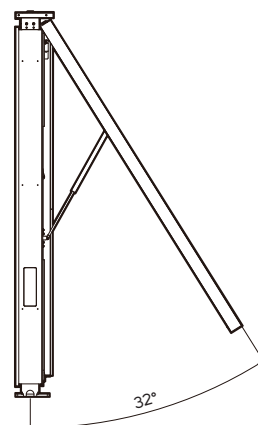
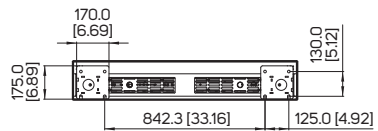
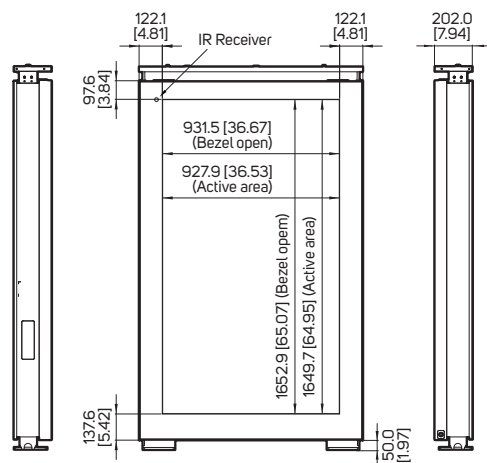
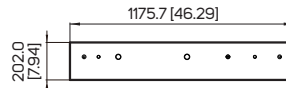
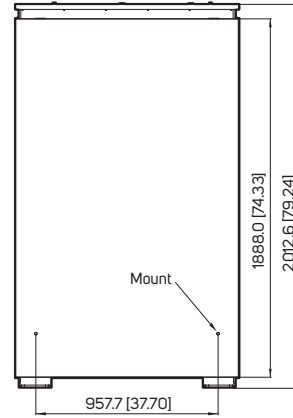
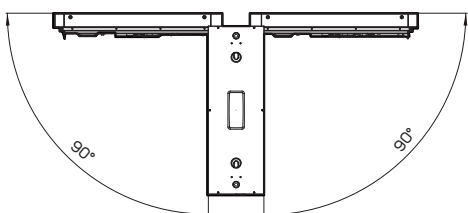
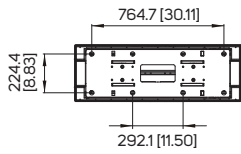
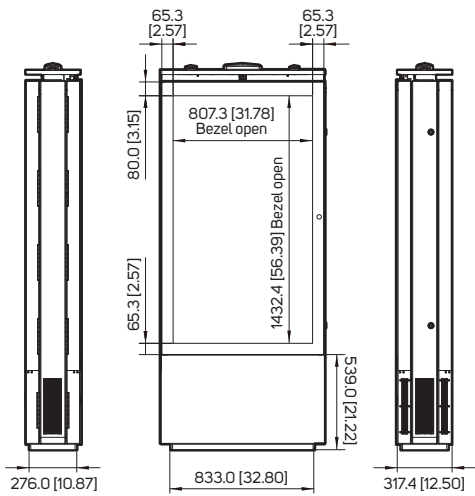
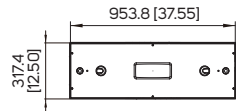
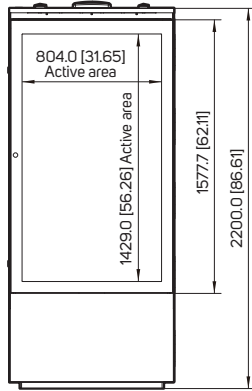

# DIMENSIONS

All specifications subject to change without notice.

## 75" 4K UHD DUAL-SIDED OUTDOOR KIOSK

## 75" 4K UHD DUAL-SIDED HYBRID KIOSK WITH LIGHT BOX

Model

DK751DN5

DK751DH5

Unit: mm [inch]

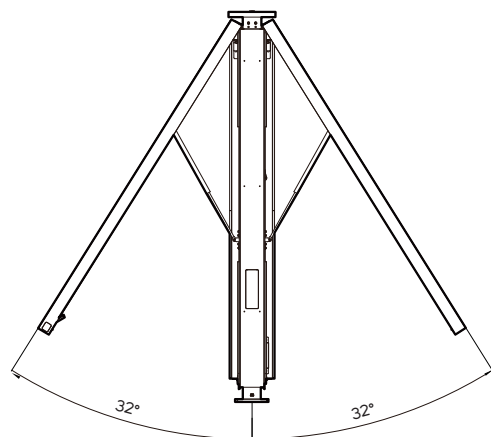
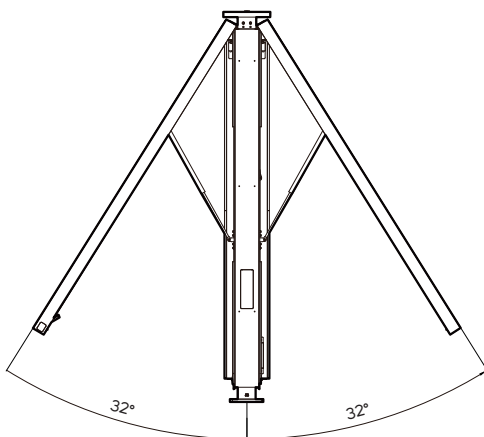
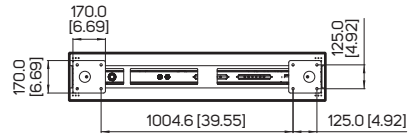
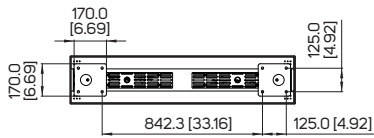
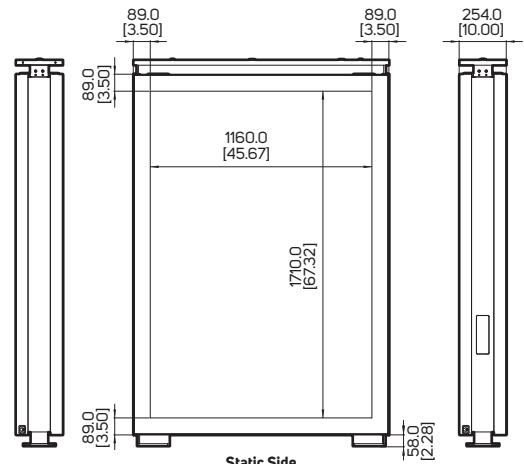
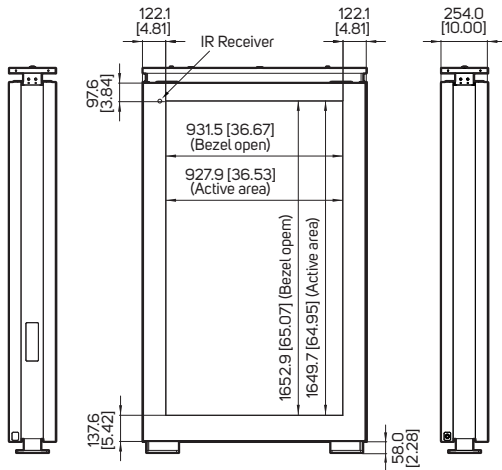
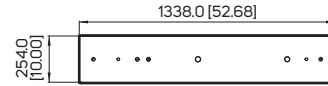
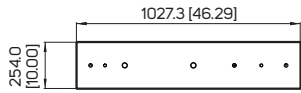
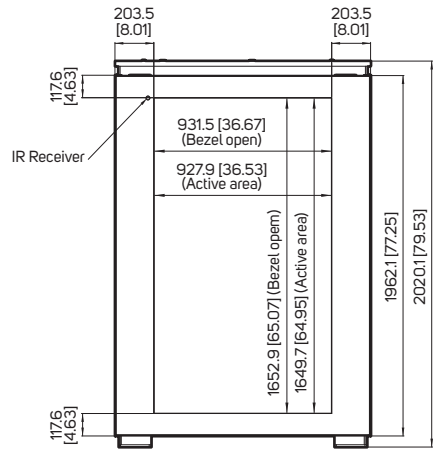
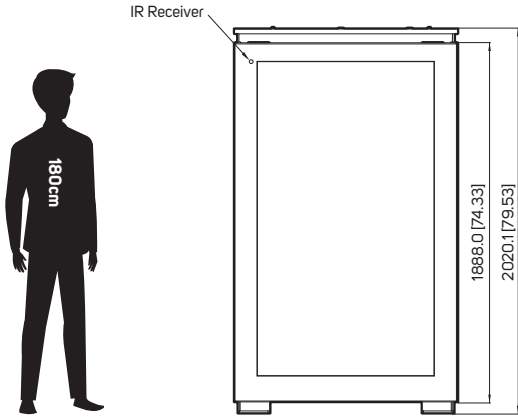

# DIMENSIONS

All specifications subject to change without notice.

## 86" 4K UHD DUAL-SIDED OUTDOOR KIOSK

## 86" 4K UHD SINGLE-SIDED OUTDOOR KIOSK

Model

DK861DR4

DK861LR4

Unit: mm [inch]

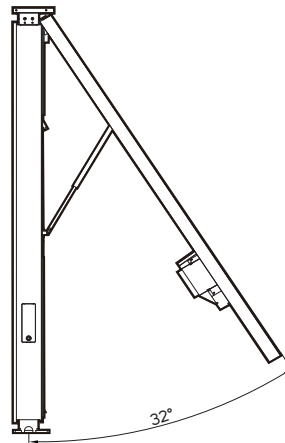
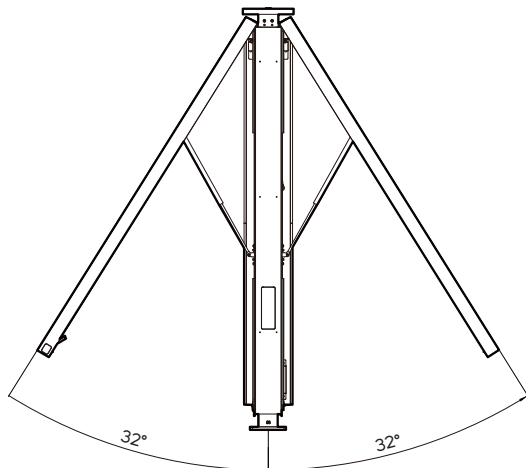
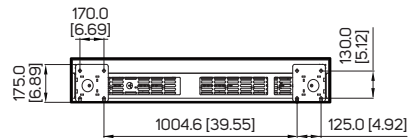
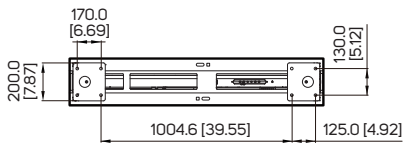
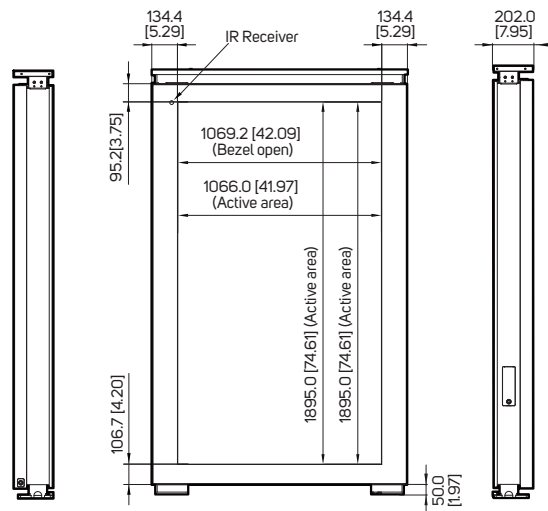
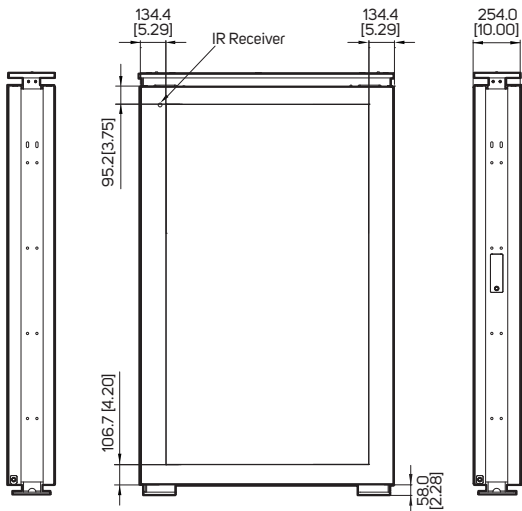
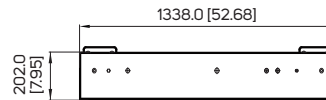
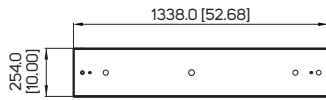
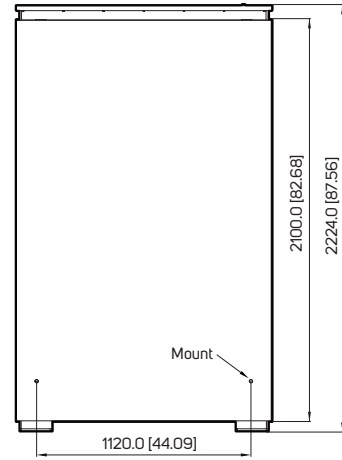
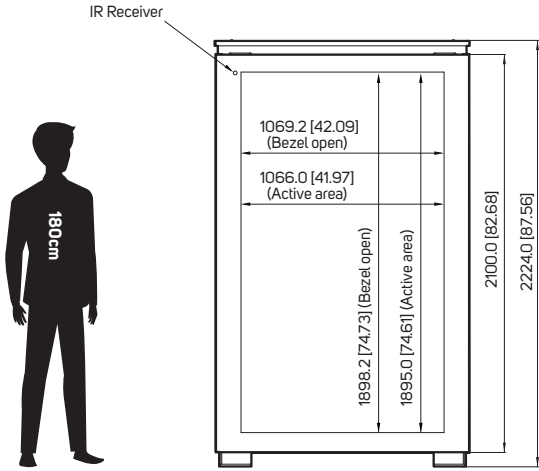

# DIMENSIONS

All specifications subject to change without notice.

## 86" 4K UHD DUAL-SIDED HYBRID KIOSK WITH LIGHT BOX

Model

DK861DH4

Unit: mm [inch]

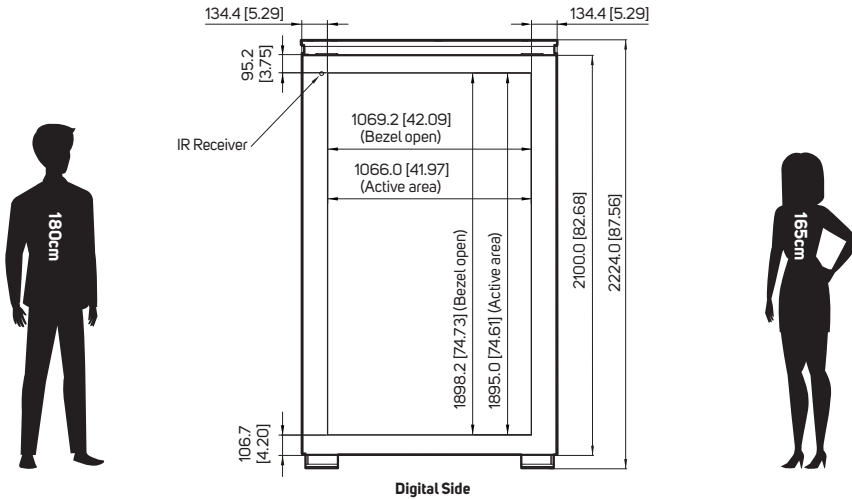

Digital Side

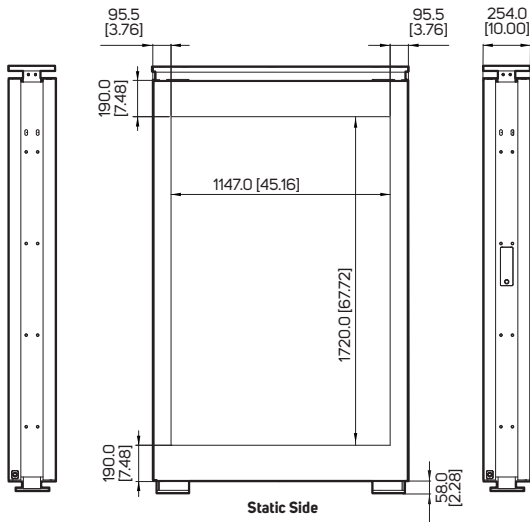
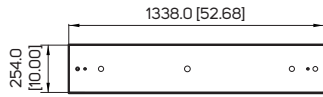

Static Side

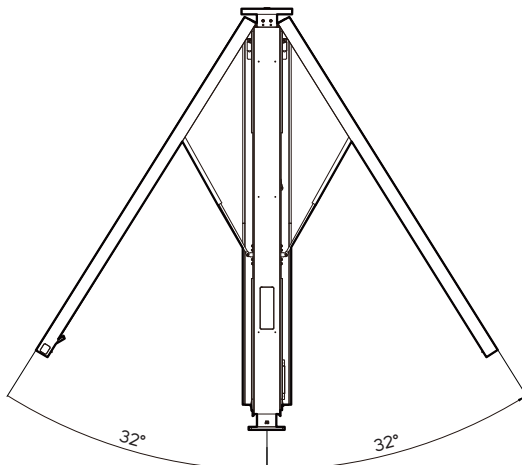
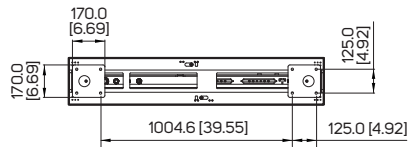

# SPECIFICATIONS

All specifications subject to change without notice.

	<b>65" DUAL-SIDED OUTDOOR KIOSK</b>	<b>75" 4K UHD SINGLE-SIDED OUTDOOR KIOSK</b>	<b>75" 4K UHD DUAL-SIDED OUTDOOR KIOSK</b>	<b>75" 4K UHD DUAL-SIDED HYBRID KIOSK WITH LIGHT BOX</b>	
	Model DK651DR5	DK751LN5	DK751DN5	DK751DH5	
<b>DISPLAY</b>	LCD Panel Size	65" (x2)	74.52"	74.52" (x2)	74.52"
	Native Resolution	1920 x 1080	3840 x 2160	3840 x 2160	3840 x 2160
	Brightness	4000 nits	4000 nits	4000 nits	4000 nits
	Color Depth	10 bits	10 bits	10 bits	10 bits
	Contrast Ratio	4000 : 1	3000 : 1	3000 : 1	3000 : 1
	Light Lifetime (Typ.)	100,000 hrs	100,000 hrs	100,000 hrs	100,000 hrs
	Viewing Angle	178° / 178°	178° / 178°	178° / 178°	178° / 178°
	Polarized Sunglasses Support	Yes	Yes	Yes	Yes
	Orientation	Portrait	Portrait	Portrait	Portrait
<b>TOUCH (OPTIONAL)</b>	Detection Method	Projected Capacitive Touch Technology	Projected Capacitive Touch Technology	Projected Capacitive Touch Technology	Projected Capacitive Touch Technology
	Input Method	Finger and Gloved Finger	Finger and Gloved Finger	Finger and Gloved Finger	Finger and Gloved Finger
	Noise Shielding	Yes	Yes	Yes	Yes
	Number of Simultaneous Touches	Max. 40 points	Max. 40 points	Max. 40 points	Max. 40 points
<b>POWER</b>	Rated Voltage	200-240V ~ 50/60Hz	100-240 V~ 50/60Hz	200-240 V~ 50/60Hz	100-240 V~ 50/60Hz
	Power Consumption (Typ./Max)	650W / 2000W	470 W / 950 W	850 W / 1850 W	550 W / 1000 W
<b>MECHANICAL SPECS</b>	Cabinet Color	Black	Black	Black	Black
	Kiosk Dimension (LxHxD)	953.8 x 2200 x 317.4 mm	1175.7 x 1962.1 x 202.0 mm	1175.7 x 1962.1 x 254.0 mm	1338.0 x 1962.0 x 254.0 mm
	Kiosk Weight	380 kg	280 kg	415 kg	< 350 kg (lightbox excluded)
	Glass	Double Laminated Tempered	Double Laminated Tempered	Double Laminated Tempered	Double Laminated Tempered
	Air Vent	Top & Bottom	Top & Bottom	Top & Bottom	Top & Bottom
	Base	539.0 mm H	50.0 mm H	58.0 mm H	58.0 mm H
<b>LIGHT BOX</b>	Bezel Width (T/B/L/R)	-	-	-	89 / 89 / 89 / 89 mm
	Poster Size (WxH)	-	-	-	1200 x 1800 mm
	Kiosk Visual Opening (WxH)	-	-	-	1160 x 1710 mm
<b>FEATURE</b>	Image Retention Protection	Yes	Yes	Yes	Yes
	Ambient Light Sensor	Yes	Yes	Yes	Yes
	Power On/Off Scheduling	Yes	Yes	Yes	Yes
<b>INPUT</b>	HDMI 2.1 (HDCP 2.3)	x6 (1080p recommended)	x3 (2160p)	x6 (2160p)	x3 (2160p)
	DisplayPort 1.2	x2	x1	x2	x1
	USB 3.0	x2	x1	x2	x1
	Micro SD Slot	x2	x1	x2	x1
<b>ENVIRONMENT</b>	Operating Temperature	-30° C ~ 50° C	-30° C ~ 50° C	-30° C ~ 50° C	-30° C ~ 50° C
	Storage Temperature	-20° C ~ 60° C	-20° C ~ 60° C	-20° C ~ 60° C	-20° C ~ 60° C
	Humidity	10% ~ 100% RH Non-condensing	10% ~ 100% RH Non-condensing	10% ~ 100% RH Non-condensing	10% ~ 100% RH Non-condensing
	Water and Dust Resistant Design	IP56	IP56	IP56	IP56
<b>CERTIFICATION</b>	CE / FCC / RoHS	CE / FCC / IEC60950-22 / RoHS	CE / FCC / IEC60950-22 / RoHS	CE / FCC / IEC60950-22 / RoHS	



# SPECIFICATIONS

All specifications subject to change without notice.

	86" 4K UHD DUAL-SIDED OUTDOOR KIOSK	86" 4K UHD SINGLE-SIDED OUTDOOR KIOSK	86" 4K UHD DUAL-SIDED HYBRID KIOSK WITH LIGHT BOX	
Model	DK861DR4	DK861LR4	DK861DH4	
<b>DISPLAY</b>	LCD Panel Size	85.6" (x2)	85.6"	85.6"
	Native Resolution	3840 x 2160	3840 x 2160	3840 x 2160
	Brightness	3500 nits	3,500 nits (digital side)	3,500 nits (digital side)
	Color Depth	10 bits	10 bits	10 bits
	Contrast Ratio	3000 : 1	3000 : 1	3000 : 1
	Light Lifetime (Typ.)	100,000 hrs	100,000 hrs	100,000 hrs
	Viewing Angle	178° / 178°	178° / 178°	178° / 178°
	Polarized Sunglasses Support	Yes	Yes	Yes
	Orientation	Portrait	Portrait	Portrait
<b>TOUCH (OPTIONAL)</b>	Detection Method	Projected Capacitive Touch Technology	Projected Capacitive Touch Technology	Projected Capacitive Touch Technology
	Input Method	Finger and Gloved Finger	Finger and Gloved Finger	Finger and Gloved Finger
	Noise Shielding	Yes	Yes	Yes
	Number of Simultaneous Touches	Max. 40 points	Max. 40 points	Max. 40 points
<b>POWER</b>	Rated Voltage	200-240 V ~ 50/60Hz	200-240V ~ 50/60Hz	200-240V ~ 50/60Hz
	Power Consumption (Typ./Max)	1300 W / 2700 W	650 W / 1300 W	720 W / 1500 W
<b>MECHANICAL SPECS</b>	Cabinet Color	Black	Black	Black
	Kiosk Dimension (LxHxD)	1338.0 x 2174.0 x 254.0 mm	1338.0 x 2174.0 x 202.0 mm	1338.0 x 2174.0 x 254.0 mm
	Kiosk Weight	500 kg	325 kg	401 kg (lightbox excluded)
	Glass	Double Laminated Tempered	Double Laminated Tempered	Double Laminated Tempered
	Air Vent	Top & Bottom	Top & Bottom	Top & Bottom
	Base	58.0 mm H	50.0 mm H	58.0 mm H
<b>LIGHT BOX</b>	Bezel Width (T/B/L/R)	-	-	190.0 / 190.0 / 95.5 / 95.5 mm
	Poster Size (WxH)	-	-	1200 x 1800 mm
	Kiosk Visual Opening (WxH)	-	-	1160.0 x 1710.0 mm
<b>FEATURE</b>	Image Retention Protection	Yes	Yes	Yes
	Ambient Light Sensor	Yes	Yes	Yes
	Power On/Off Scheduling	Yes	Yes	Yes
<b>INPUT</b>	HDMI 2.1 (HDCP 2.3)	x6 (2160p)	x3 (2160p)	x3 (2160p)
	DisplayPort 1.2	x2	x1	x1
	USB 3.0	x2	x1	x1
	Micro SD Slot	x2	x1	x1
<b>ENVIRONMENT</b>	Operating Temperature	-30° C ~ 50° C	-30° C ~ 50° C	-30° C ~ 50° C
	Storage Temperature	-20° C ~ 60° C	-20° C ~ 60° C	-20° C ~ 60° C
	Humidity	10% ~ 100% RH Non-condensing	10% ~ 100% RH Non-condensing	10% ~ 100% RH Non-condensing
	Water and Dust Resistant Design	IP56	IP56	IP56
<b>CERTIFICATION</b>	CE / FCC / IEC60950-22 / RoHS	CE / FCC / IEC60950-22 / RoHS	CE / FCC / IEC60950-22 / RoHS	

# WORLDWIDE OFFICES

With offices in Europe, North America, and Asia, DynaScan is equipped for international rollouts and support.

## NORTH AMERICA

### UNITED STATES

---

7 Chrysler, Irvine, CA 92618, United States of America  
T +1 949 421 0348 T +1 866 408 4848  
info@dynascandisplay.com

## ASIA

### TAIWAN

---

6F, No. 88, Wenmao Rd., Guishan Dist.,  
Taoyuan City 333001, Taiwan  
T +886 3 396 0541 F +886 3 396 0545  
info@dynascan.com.tw

### CHINA

---

3F Building 40, No. 333 Qin Jian Rd. 200233,  
Shanghai, China  
T +86 21 6495 9900  
info@dynascandisplay.com

### JAPAN

---

888 Nippa-cho, Kouhoku-ku, Yokohama-shi,  
Kanagawa, 223-0057 Japan  
T +81 45 716 6699  
info@dynascandisplay.co.jp

## EUROPE

### THE NETHERLANDS

---

Operetteweg 41, 1323 VK Almere, The Netherlands  
T +31 850239690  
info@dynascandisplay.com

### GERMANY

---

Südtirolerstr. 9, 86165 Augsburg, Germany  
T +49 (0)151 40806591  
info@dynascandisplay.com

### UNITED KINGDOM

---

1st Floor, Building 3 Concorde ParkMaidenhead,  
SL6 4BY United Kingdom  
T +44 162 842 1570 F +44 162 846 1222  
info@dynascandisplay.com

### FRANCE

---

T +33 (0)7 77 32 73 51  
info@dynascandisplay.com

### SPAIN

---

T +34 672 133 106  
info@dynascandisplay.com

# Unifying Visions

*DynaScan*



**DynaScan**

[www.dynascandisplay.com](http://www.dynascandisplay.com)

Copyright © DynaScan Technology, Inc. All Rights Reserved

